

FALCON 400G2

AUTOMATIC HARDNESS TESTER

VICKERS, MICRO VICKERS, KNOOP & BRINELL



FALCON 400G2

Success is a journey...

The FALCON 400G2 is the second generation of an essential range of Micro Vickers / Vickers / Brinell hardness testing machines. Combining traditional hardness testing methods with latest updates on technology and requirements to meet the applicable DIN EN ISO ASTM and JIS standards while providing maximum user comfort.



A state-of-the-art, multi load cell test force actuator, with a test range of 1gf up to 62.5kgf allowing the 400G2 to provide a force application band width, that hasn't been available in this category of machines anywhere before. Electronic motorized systems on two high precision ball screw Z-axis, arranges maximum control over the force range as well as the workpiece positioning.

The 6 position turret, with collision detection & retraction system is equipped with high quality objectives that remain automatically focused on the workpiece surface, while changing between objectives. Innovative dynamic Z-axis movement over a magnification (objective) depending electronic handwheel, a unique feature that can only be found on the FALCON 400G2.

The robust I-TOUCH™ workflow control unit, won't be damaged from falling objects, while the intuitive software gives access to easy workflow control over the hardness testers functions.



HARDNESS SCALES

	VICKERS	1gf - 60kgf
	KNOOP	1gf - 5kgf
	BRINELL	1 kgf - 62.5kgf

Select your required test force range...

1gf	5gf	2kgf		FALCON 400G2 - OPTION 1*	62.5kgf
1gf	10gf	2kgf		FALCON 400G2 - OPTION 2	62.5kgf
1gf	10gf	10kgf		FALCON 400G2 - OPTION 3	62.5kgf
1gf	10gf		31.25kgf	FALCON 400G2 - OPTION 4	62.5kgf
1gf	10gf			FALCON 400G2 - OPTION 5	62.5kgf
1gf		200gf		FALCON 400G2 - OPTION 6	62.5kgf

Upgrade now, later, at any moment, during order or online!

EXTENSION A**	0.1gf - 1gf	EXTENSION B	1gf - 10gf	EXTENSION C	10gf - 200gf
EXTENSION D	2kgf - 10kgf	EXTENSION E	10kgf - 31.25kgf	EXTENSION F	31.25kgf - 62.5kgf

* Fixed force range, can not upgrade.

**Not available for this model

HIGHLIGHTS

- 1 Multi Load Cell, Closed Loop system, no weights
- 2 Configure load range 1gf – 62.5kgf, on demand
- 3 Electronic eyepiece, automatic hardness display
- 4 Electronic Z- axis handwheel, dynamic displacement
- 5 Motorized high precision ball screw Z-axis spindle
- 6 Fast Up/Down controls
- 7 i-TOUCH™ powerful tester and function control
- 8 Auto Focus between objectives
- 9 Optional IMPRESSIONS™ XT automation software



LOGICAL INNOVATION

How innovation leads to progress...

Rock solid, innovative machine structure with ABS shells and external display. Dual ball screw Z-axis technology to distribute test force application and workpiece/focus displacement across 2 independent motorized actuators. The first Z-axis there is dynamic motion controlled work stage, allowing the workpiece to be positioned precisely towards the indenter or focus position This goes quickly and conveniently at up to 30mm/s. The second Z-axis offers a high-resolution and therewith high precision force application.

With a workpiece accommodation of 145 mm x 170 mm the FALCON 400G2 can be routinely used to conduct common advanced testing tasks.

New insights...

1 6 POSITION, FAST TURRET, AUTO FOCUS BETWEEN OBJECTIVES

The 6 position turret is supplied as a standard feature on all 400G2 models and allows to install indenters for Vickers, Knoop and Brinell (balls 1mm, 2,5mm and 5mm) testing.

The precision Swiss precision mechanics of the motorized turret permit super-fast and quiet positioning. Switching between indenter and objective is part of the automated test cycle. 6 positions, with maximum 2 indenters, and 4 objective positions allowing you to install all the magnification power required for your application.

2 DIGITAL, ANALOGUE EYEPIECE WITH OPTIONAL BUILT IN CAMERA

The FALCON 400G2 digital eyepiece can be replaced by an analogue eyepiece for educational purposes. An installation of both eyepieces is also possible. Optional IMPRESSIONS™ IMP camera & software system is available.

By accommodating the camera inside the test head, protected by the test head cover, the camera is safe from dirt and accidental damage or misalignment. This installation also avoids visible wiring on the outside of the machine

3 COLLISION DETECTION

The turret of the 400 detects any collision with the indenters or objectives, and will automatically retract the workpiece from the collision situation, avoiding damage to the machine and the workpiece.

4 MOTORIZED, DYNAMIC DISPLACEMENT Z-AXIS

Unique in this market segment, is the motorized high precision ball screw Z-axis. The electronic handwheel on the side of the tester, provides dynamic control over the z-axis displacement. With low magnification each turn on the spindle wheel will give a high displacement, while with the use of 50X or 100X objectives, with less focus depth, much more precision and less displacement is required from each handwheel turn. The 400G2 gives users control on Z-axis movement in correlation with the requirements of each installed objective.

5 6.5" FULL COLOUR HD TOUCHSCREEN, I-TOUCH™

All machine control and process workflow can easily be operated from the 6.5" full-color HD touchscreen. Mounted on a table stand, the display with smart Graphical User Interface (GUI), flexible in use, can be located either on the right or left of the machine for right or left handed operators. Due to its tilt function the display can be set up in such a way that either in standing or sitting position, the viewing and operating angle is always ideal.



6 SHOCK RESISTANT ABS MACHINE COVERS

A rock solid frame structure, that can withstand the harshest environment, is covered by shock and damage proof ABS covers. The covers avoid damage to the machines high tech interior and stay in a good condition over the years to come. No dents or paint damage from fallen work pieces. Replacement of the covers, if required at all, is easy and economic.

Innovative software functions

The I-TOUCH™ software provides clever multi-function keys for testing, set-up, storing and uploading of test programs, statistic control and more, making tester operation as easy as it can be. Data export, single or batch readings, with a single press on a button, or just fully automatic after measurement can be stored on a USB stick or transfer by cable to a PC to be imported or evaluated in EXCEL.

Further advanced features include extended statistics, shape correction for convex, concave or ball shaped specimens, hardness conversion to Rockwell, Brinell or Tensile strength according to ASTM E140 and ISO 18625 with different material tables.

The table top panel with a adjustable viewing angle is mounted in a solid robust aluminum frame.



OPERATING COMFORT WITH I-TOUCH

INNOVATIVE SOFTWARE FUNCTIONS

1 OUT OF SET LIMITS

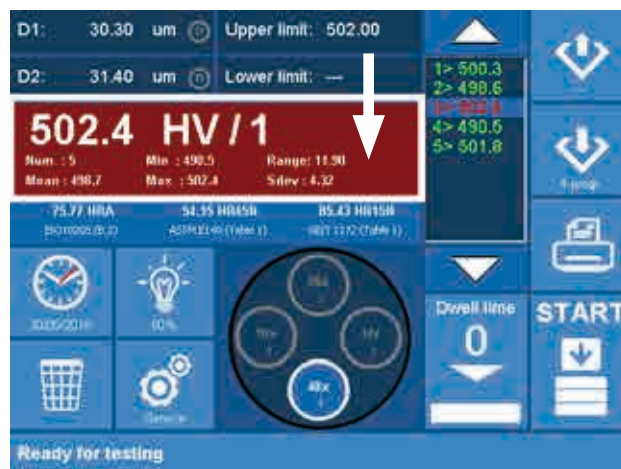

2 UNMISTAKEN TURRET POSITION



3 MEASUREMENT OVERVIEW



4 EXPORT FUNCTIONS



OPTIONAL AUTOMATIC INDENT EVALUATION

Indent evaluation software, also referred to as “tester automation”, often comes with a high level of complexity, both in setup and in operation. Breaking these rules, IMPRESSIONS™ XT (optional) focuses on fast and simple operation, for a less experienced operator.

A very easy to learn, workflow process but with functionality expected by expert users. IMPRESSIONS™ is optimized for evaluating Macro-Vickers, Micro-Vickers, Knoop & Brinell indents according to ISO, ASTM and JIS standards.

SELECT YOUR INDENT EVALUATION PACKAGE:

1 STANDARD (IMP-PACK2)

IMPRESSIONS™ Software for manual and automatic measurement of Vickers / Knoop & Brinell indents, indent zoom function, automatic illumination adjustment.

Package Includes:

*High performance system controller with USB, HDMI, RS-232, WLAN, LAN connectivity. Industrial DVI/HDMI capacitive touchscreen, with wireless keyboard and mouse, 11 Mpx HD industrial CCD camera, cable set.

Software features: Full tester configuration & control system, automatic brightness & contrast setting, automatic measurement of Vickers, Knoop and Brinell indents, manual CHD, SHD, NHD testing procedure, Kic measurement, set up and storing of test programs, set up and storing of tester configuration, limits (go/no go), diagrams, advanced report generator with editor.

NO INSTALLATION, NO ADDITIONAL PC REQUIRED!

2 ADVANCED (IMP-PACK3 & IMP-PACK4)

As STANDARD package but offers two options :

IMP-3 has one digital micrometre X-axis that transfers the position of the stage to IMPRESSIONS™, whereas IMP-4 has two digital micrometres that transfer the position of the stage to IMPRESSIONS™.



AUTOMATIC IMAGE EVALUATION

AUTOMATIC MEASUREMENT

Manual positioning of filar lines is no longer required. IMPRESSIONS™ refined measurement algorithms detect indents even on very poor or scratched surfaces and measure the relevant indent dimensions according to standards. Stay in control by switching to manual measure mode and have the option of adjusting measurements by touching the screen or using the mouse. Filar lines can be colored to give the best contrast against the specimen's surface. To assure that measurements meet relevant standards on symmetry, enable the automatic indent check. All hardness values can be converted to other scales according to ISO 18265, ISO 50150, ASTM E140.

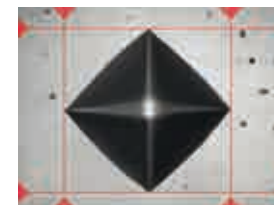

ILLUMINATION SETTINGS

IMPRESSIONS™ software automatic illumination system adapts to the correct illumination regardless of the sample surface quality, wherever on the sample, independent from material (steel, carbide, coated or ceramic). Contrast, Brightness and program, can be set automatically for each measurement or controlled manually. Sharpness can be stored with the pre-determined test.

Too bright



OK



Too dark



Irregular surface



Regular surface



Poor surface

Complex, refined algorithms ensure reproducible measurements on different materials and even on scratched and damaged surfaces.

TIME REDUCING SOFTWARE SOLUTIONS...

1 PATTERN EDITOR

The IMPRESSIONS™ pattern editor allows the user to create any number of test patterns with a large number of variable settings. Create test patterns with great precision and freedom. Verify the settings in the preview mode. Drag & drop patterns from one test sample to another sample. Live vision technique over zoom overview camera, no image stitching required.

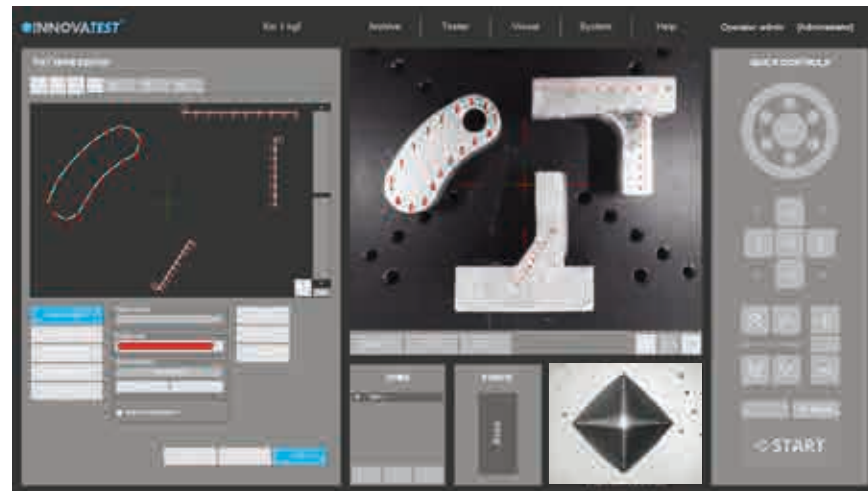

Combine different patterns and even different test forces in one program, and run them fully automatically. All test points can be identified individually or to customer specifications. The label is shown in the test result list and in the test results overview and in the results print out. An important function for sample analyses at the end of a test and in the future for review of previous tests.

2 CHD, SHD, NHD

How do you increase throughput in your lab? Make the most common testing design as easy to set up as possible to perform automatically and still adhere to the applicable standards. CHD/SHD/NHD testing can be started directly from the surface view or from the overview. Additional core points of hardness can be defined separately for NHD measurements.

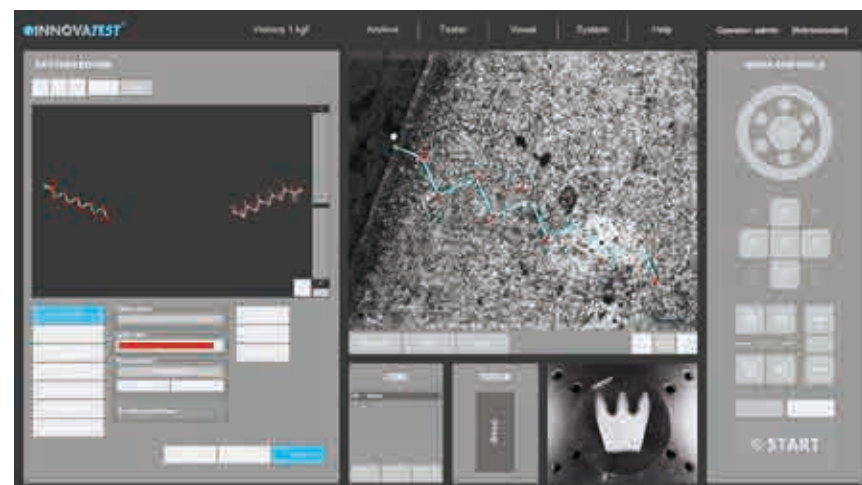

The distances of test points are automatically set to a minimum distance, following the standard, to assure correct testing is conducted. Time saving test mode "complete all indentations - then evaluate" and "auto-stop" to complete test series as soon as the lower hardness limit has been reached. Report Generator is enhanced with reporting features for this application.

3 WELD INSPECTION (ISO 9015)

This especially developed tool enables you to conduct hardness testing on welded parts or segments according to ISO standard. Setting up the pattern according to the requirements becomes "easy-to-do", due to pre-set test points in the different zones of the weld and automatic correlation between test points. The system will run a fully automatic test procedure and display and record the results accordingly. The Report Generator is enhanced with reporting features for this application.

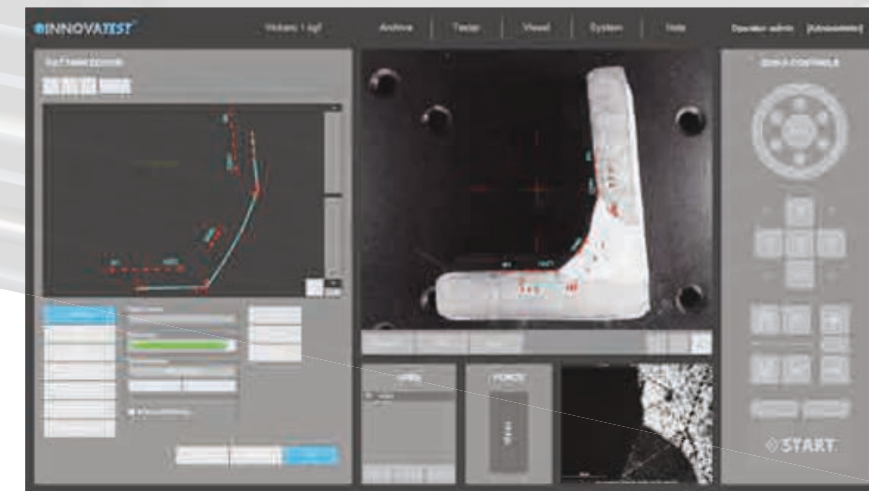

4 HARDNESS OF SCREW THREAD DECARBONIZED ZONE (ISO898-1)

A specialized software tool of IMPRESSIONS™ allows you to set up and conduct fully automatic testing as per ISO898-1 for screw thread measurement of (de)-carbonized part.

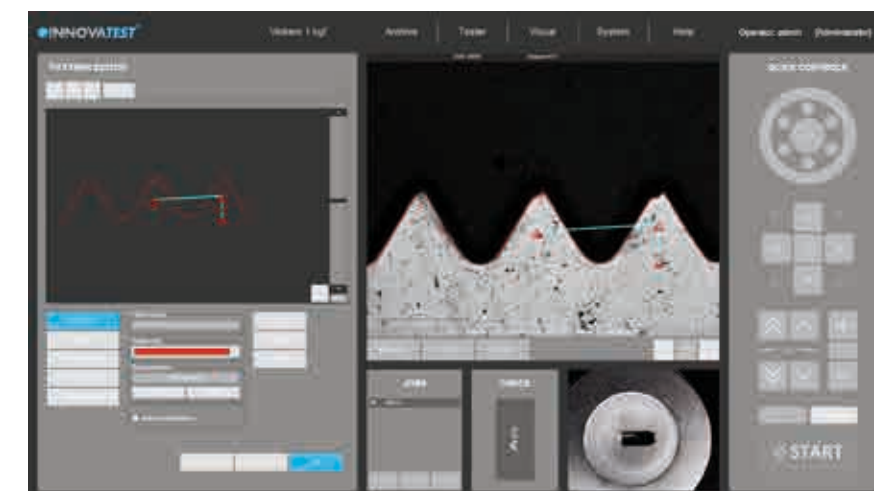

The Report Generator is enhanced with reporting features for this application.

5 EDGE DETECTION

Technology that automatically or at a mouse click recognizes the edge of your sample. This helps to determine and fix the desired starting position for CHD or other pattern testing jobs.

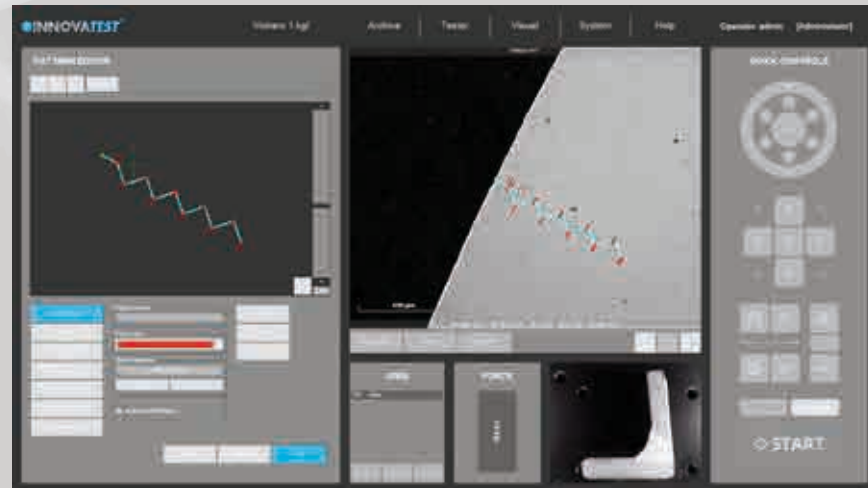

7 2D HARDNESS CHART

The application „Plane hardness chart“, is also referred to as Color Mapping happens to be the perfect tool for securing the detail of the effective hardness distribution over the total sample cross section of heat treated samples. An important feature in material exploration, weld testing or in damage analysis.

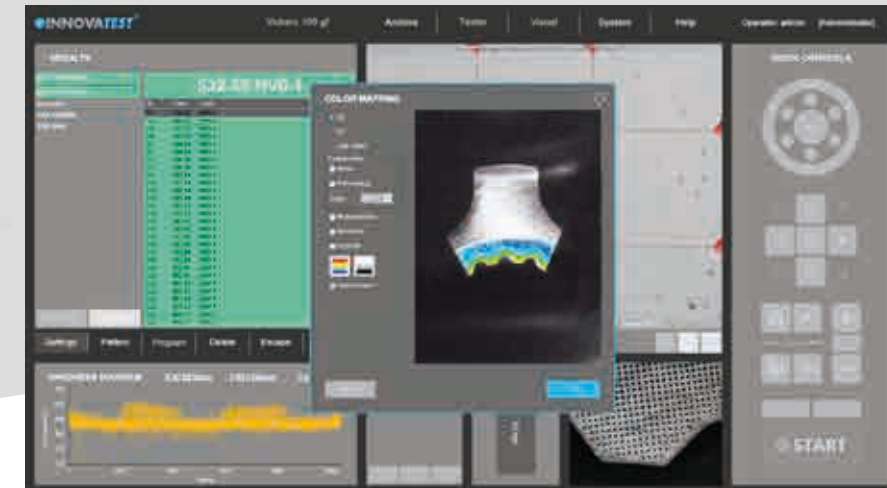

6 AUTOMATIC CONTOUR SCANNING

This application scans the entire outline (or partial) area of a sample. The function can be used with an objective by using the overview zoom camera for high speed scanning. The system scans the entire outline defined and stores all relevant data in the test program.

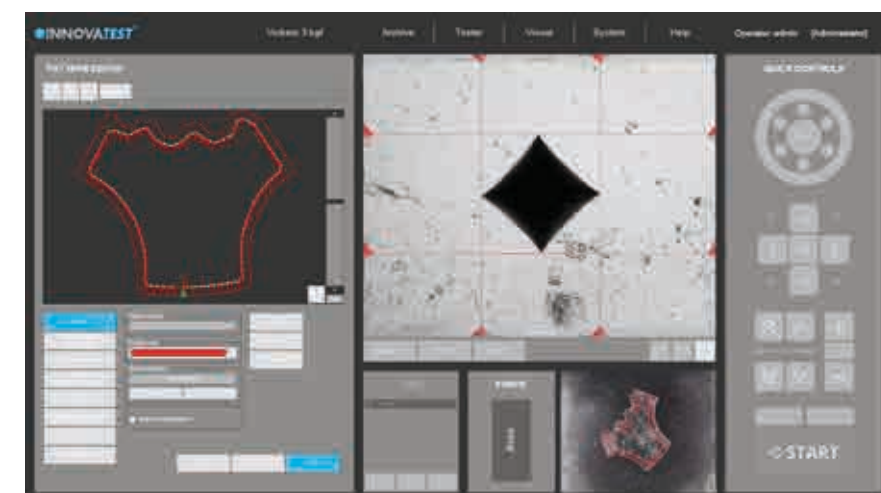

8 3D HARDNESS CHART

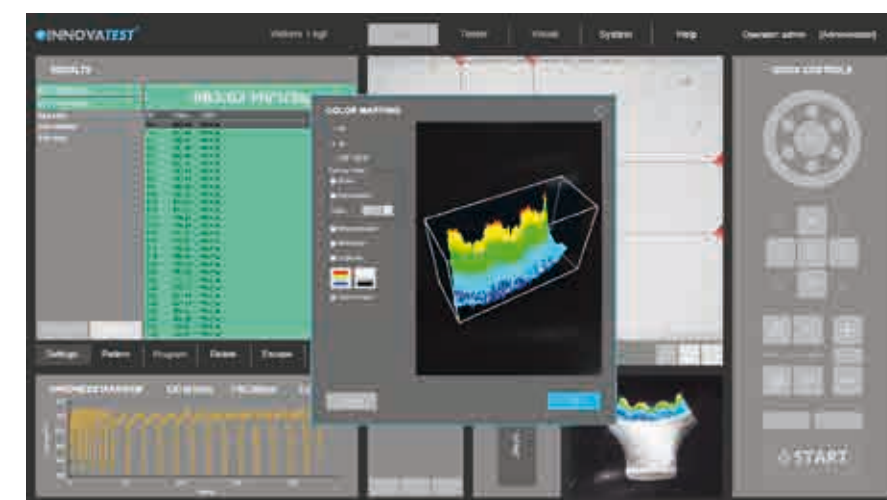

In addition to 2D graphic diagrams, the system can also automatically generate 3D diagrams. 2D and 3D hardness charts are included in one application.

Subsequently, a limitless number of test points can be inserted into the scanned image, or be set at selected distances (offset), relative to the edge. This advanced feature enables the hardness testing procedure to be performed c. An excellent featured combined with 2D or 3D hardness mapping, also known as “plane hardness chart”.

9 Kic CRACK MEASUREMENT

For those requiring more in depth knowledge on materials behavior, wishing to study material fracture and fatigue, crack growth can be predicted and measured by using the Kic application.

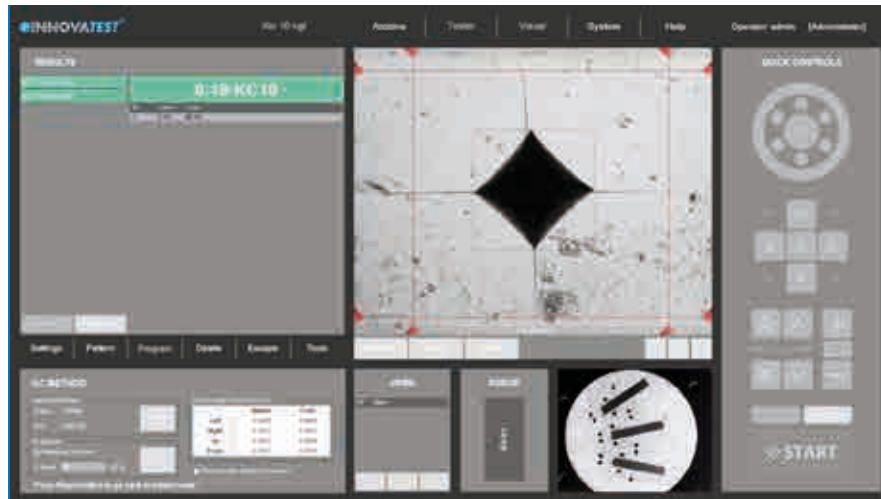

The software supports Kic crack detection under load with customized Kic result reporting. By way of one or both methods, Palmqvist or Median / Radial, fracture toughness is now a repeatable and reproducible test across multiple operators.

10 SNAPSHOT FUNCTION

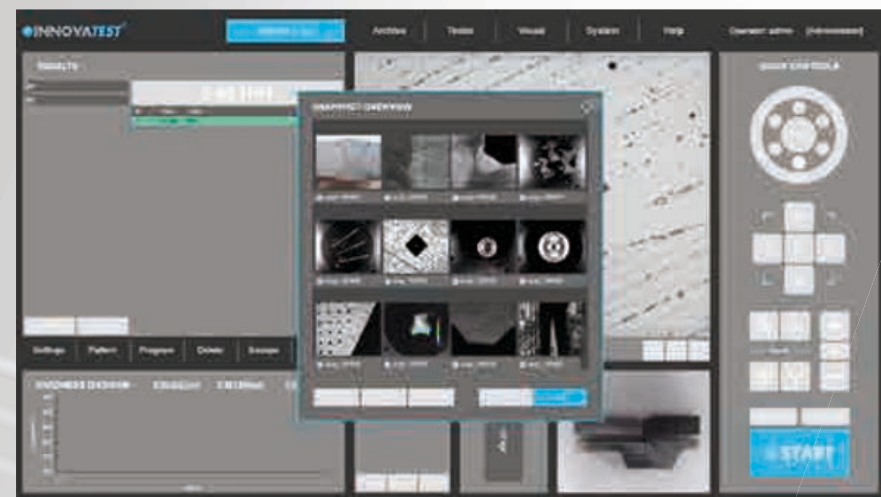

This handy function in IMPRESSIONS™ allows you to make screen captures of the viewing area by way of objective view and/or Overview camera. It gives the opportunity to store such images with comments or to paste them into the report generator for further processing.

11 USER DEFINED PROGRAMS

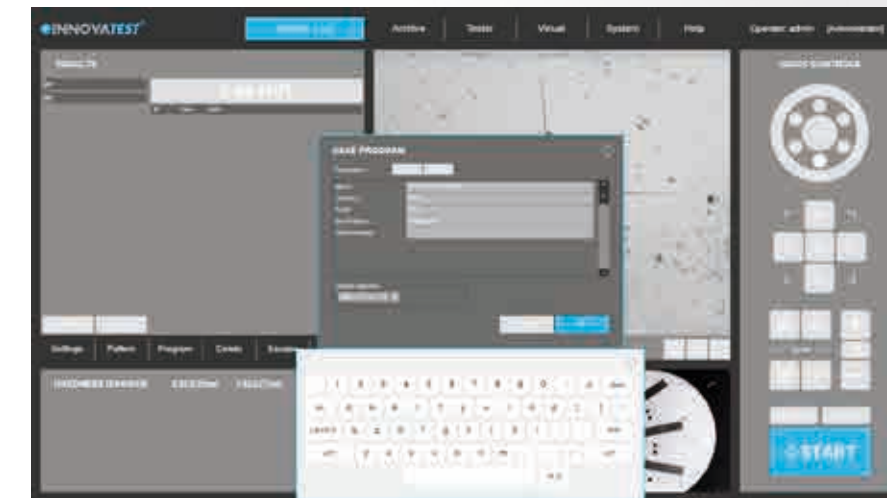

For repeating jobs, IMPRESSIONS™ utilizes the option of setting up and storing custom test programs. For each task, a "job" can be created. All application specific parameters, such as hardness scale, force, dwell-time, pattern, conversion and the report template are stored in the same program.

12 REPORT GENERATOR

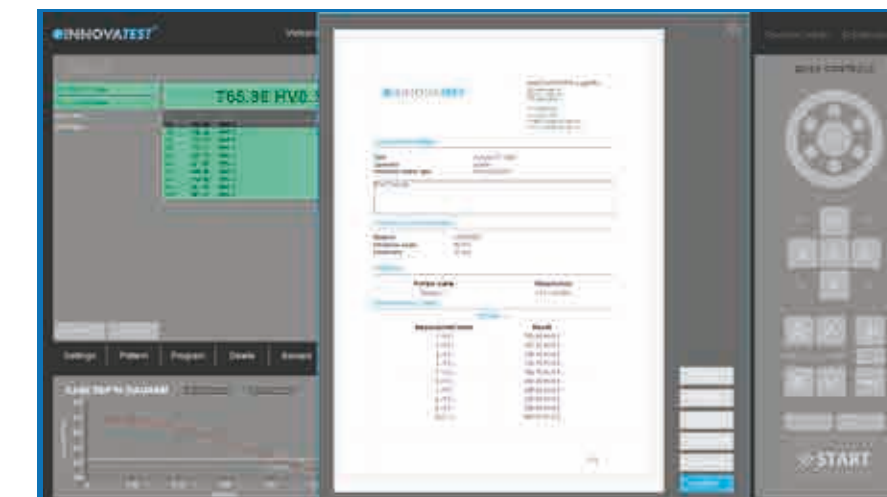

Imagine having a report created for you that includes: Your company name, address, contact information, labeled results related to patterns or sequential, pictures of your optical measurements, stitched images, notes section for each result or pictures, rendition of the pattern performed, overview picture of your pattern on your sample, full statistics, summary of your results, go no-go results, Pass or fail...

All this information or having the ability to only have what you need reported, we call this our Report Configurator. You decide how much or how little you report by PDF or laser printer. We even keep it simple by choosing export to CSV file, to a thumb drive or network file location. Data management at its best!



VARIOUS POSSIBILITIES

The FALCON 400G2 is routinely used for testing materials, components or parts in the aerospace and automotive industry, laboratories for sample evaluation or to conduct advanced testing tasks. The shock and damage proof covers protect are high-tech interior of this unique Micro-Macro Vickers machine.

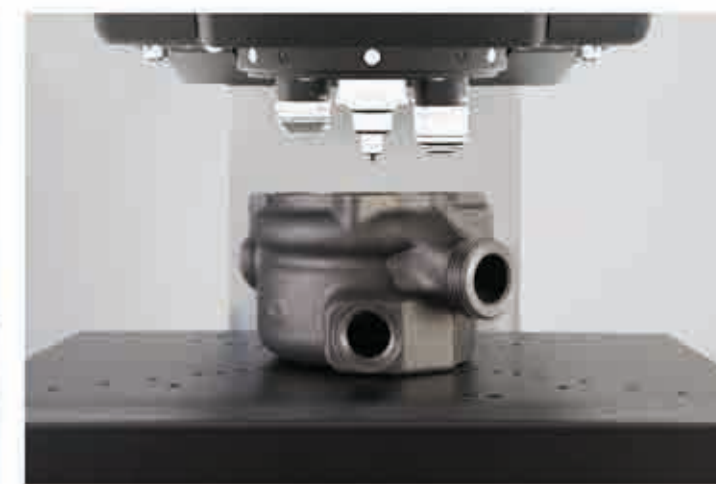
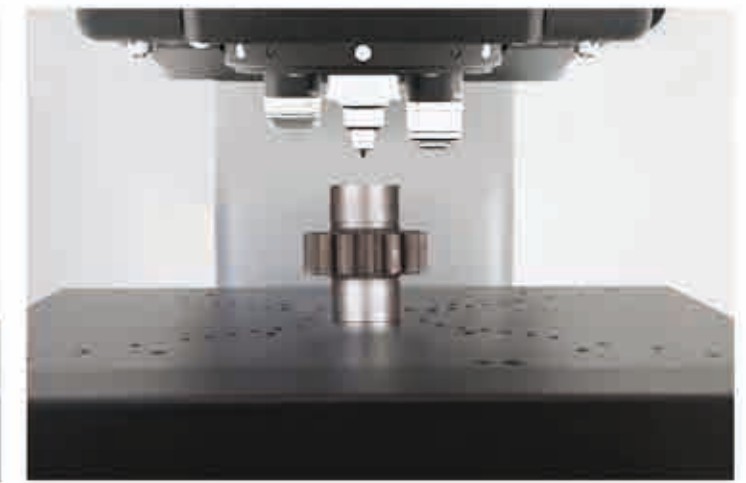



STEP 1: Select the machine



STEP 2: Force range

- OPTION 1 5gf -2kgf
- OPTION 2 10gf -2kgf
- OPTION 3 10gf -10kgf
- OPTION 4 10gf - 31.25kgf
- OPTION 5 10gf - 62.5kgf
- OPTION 6 200gf - 62.5kgf

- EXTENSION A N/A
- EXTENSION B 1gf - 10gf
- EXTENSION C 10gf - 200gf
- EXTENSION D 2kgf - 10kgf
- EXTENSION E 10kgf - 31.25kgf
- EXTENSION F 31.25kgf -62.5kgf

STEP 3: Indenters

- 1 Indenters
 - A Vickers
 - B Knoop
 - C Brinell

STEP 4: Optical

- 2 Eyepieces
 - A
 - B

- 3 Objectives
 - x5
 - x10
 - x20
 - x50
 - x100

STEP 5: Stages/Anvils

- 4 Stages
 - A
 - B
 - C
 - D

- 5 Anvils
 - A
 - B
 - C
 - D
 - E

STEP 6: Sample holders

- 6 Sample holders
 - A
 - B
 - C 25 mm
 - D 30 mm
 - E 40 mm

STEP 7: Fixtures & Vices

- 7 Fixtures & Vices
 - A
 - B
 - C
 - D
 - E
 - F
 - G
 - H
 - I
 - J

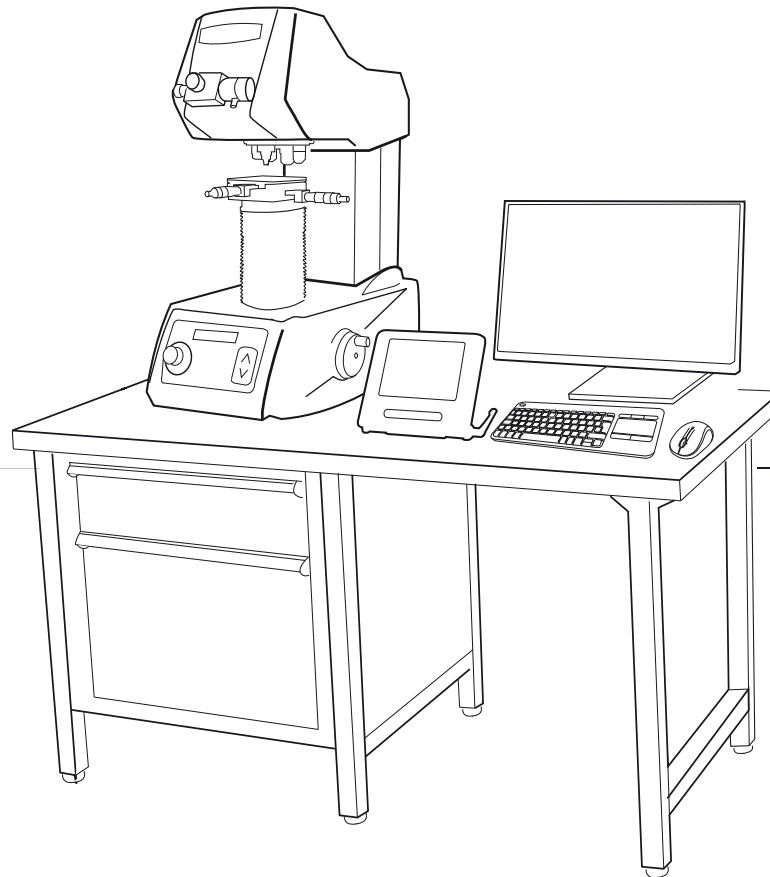

STEP 8: Software

- MANUAL ON-SCREEN MEASUREMENT
- AUTOMATIC MEASUREMENT
- REPORT GENERATOR
- SNAPSHOT FUNCTION
- VIDEO OVERLAY PATTERN EDITOR
- KIC CRACK MEASUREMENT
- DRAWING & MEASURING APPLICATION
- AUTOMATIC EDGE DETECTION
- USER LEVEL MANAGEMENT
- CHD, SHD, NHD CONFIGURATOR
- Q-DAS

✓ = Standard included with IMP-PACK

ORDER DETAILS

FALCON 400G2



FALCON 400G2 Micro hardness tester	FALCON 400G2	
OPTION 1: Force range fixed 5gf - 2kgf (can not be extended)	SLFFG201	
OPTION 2: Force range 10gf - 2kgf	SLFRG202	
OPTION 3: Force range 10gf - 10kgf	SLFRG203	
OPTION 3: Force range 10gf - 31.25kgf	SLFRG204	
OPTION 4: Force range 10gf - 62.5kgf	SLFRG205	
OPTION 6: Force range 200gf - 62.5gf	SLFRG206	
Extension A: Force range extension 0.1gf - 1gf	N/A	
Extension B: Force range extension 1gf - 10kgf	SLFRG2B	
Extension C: Force range extension 10gf - 200gf	SLFRG2C	
Extension D: Force range extension 2kgf - 10kgf	SLFRG2D	
Extension E: Force range extension 10kgf - 31.25kgf	SLFRG2E	
Extension F: Force range extension 31.25kgf - 62.5kgf	SLFRG2F	
Indenter actuator post (2nd indenter position) factory installed	FALCON/IP2	
Plug & Play prepared, calibration, sea & airworthy packing in "non coniferous wood" material	P&PSEAPACK10	

ACCESSORIES

STEP 3		Indenters			
1	Vickers	A	Micro Vickers Indenter Ø3mm ISO/ASTM certified	UPI/8105	
	Knoop	B	Micro Knoop Indenter Ø3mm ISO/ASTM certified	UPI/8205	
	Brinell	C	Brinell Indenter 1mm. Includes 1 carbide ball. Ø3mm. ISO & ASTM certified	UPI/7001	
			Brinell Indenter 2.5mm. Includes 1 carbide ball. Ø3mm. ISO & ASTM certified	UPI/7006	
			Brinell Indenter 5mm. Includes 1 carbide ball. Ø3mm. ISO & ASTM certified	UPI/7011	
STEP 4		Optical			
2	Eyepieces	A	Electronic digital eyepiece with 15x magnification	AS-EYEPIECE/03	
		B	Analogue eyepiece with 15x magnification	AS-EYEPIECE/04	
3	Objectives		5x Long Working Distance (LWD) objective	BM-05-0001	
			10x Long Working Distance (LWD) objective	BM-05-0002	STANDARD
			20x Long Working Distance (LWD) objective	BM-05-0003	
			50x Long Working Distance (LWD) objective	BM-05-0004	STANDARD
			100x Long Working Distance (LWD) objective	BM-05-0005	
STEP 5		Stages/Anvils			
4	Stages	A	Manual X-Y stage with analogue metric micrometers, 100x100mm Displacement: 25x25mm, scale 0.01mm, max load 60kg	UN-XYSTAGE/115	STANDARD < 2kgf
			Manual X-Y stage with analogue metric micrometers, 100x100mm Displacement: 25x25mm, scale 0.01mm, max load 100kg	UN-XYSTAGE/120	STANDARD ≥ 2kgf
		B	Digital micrometer, for manual X-Y stage, Displacement: 25mm, resolution 0.001mm	IMP-DIGMIC	* IMP-PACK 3,4
		C	Manual iSMART™ stage, 150x150mm, Displacement: 50x50mm	BM-08-0057	
		D	Digital control unit for Manual iSMART™ stage, 25mm travel	BM-08-0058	
			Digital control unit for Manual iSMART™ stage, 50mm travel	BM-08-0059	

			Mounting plate	AS500XL-450-02	
5	Anvils	A	V block with bracket 40x40x50mm (LxBxH)	UN-VBLOCK404050	
		B	Steel, cross type, (X) V-block 60x120x100mm 8-90mm pair	UN-CROSSBLOCK01	
		C	Small V-Anvil 3-20mm requires base plate (Requires Manual/Autom. X-Y stage)	UN-ANVILSV/105	
		D	Large V-Anvil 20-75mm requires base plate (Requires Manual/Autom. X-Y stage)	UN-ANVILLV/106	
		E	Base plate for V-anvils UN-ANVILSV/105 & UN-ANVILLV/106	UN-VANVILBASEPL	
STEP 6		Sample holders			
6	Sample holders	A	1 position sample holder, for 1 embedded sample, diameter 50mm or 2"	UN-ESH1	
		B	1 position sample holder, for 1 embedded sample, diameter 50mm or 2" with front operation elevator knob	BM-08-0052	
		C	1 insert reduction ring 25mm	UN-ESHI25	
		D	1 insert reduction ring 30mm	UN-ESHI30	
		E	1 insert reduction ring 40mm	UN-ESHI40	
			1 insert reduction ring 1"	UN-ESHI1	
			1 insert reduction ring 1 1/4"	UN-ESHI125	
			1 insert reduction ring 1,5"	UN-ESHI15	
STEP 7		Fixtures & vices			
7	Fixtures & vices	A	Polished precision vice with lock down system, jaw width 25mm, opens 20mm	UN-VICE/210	
		B	Polished precision vice with lock down system, jaw width 36mm, opens 42mm	UN-VICE/215	
		C	Polished precision vice with lock down system, jaw width 48mm, opens 75mm	UN-VICE/220	
		D	Polished precision vice with lock down system, jaw width 75mm, opens 100mm	UN-VICE/230	
		E	Axle chuck 500 series for cylinder parts, dia. 0.4mm to 5mm	UN-AXLECHUCK	
		F	Universal Clamp & Leveling Device	UN-CLAMP/105	
		G	Thin metal clamp	UN-CLAMP/115	
		H	V groove clamp for small round parts dia.0.8-5mm	UN-VGROOVE-CLAMP	
		I	Wire Testing Fixture for specimen dia. 0.8-3.5mm	UN-WIRE/105	
		J	Small parts vice jaw width 55mm, open 50mm, self centering	UN-VICE/115	
STEP 8		Software			
	Additional software		Manual on-screen measurement	UN-MANM	* IMP-PACK 2,3,4
			Automatic measurement	UN-AUTOM	* IMP-PACK 2,3,4
			Automatic focussing	UN-AUTOFOC	-
			Report configurator	UN-REPORTA	* IMP-PACK 2,3,4
			Snapshot function	UN-SNAPSH	* IMP-PACK 2,3,4
			Advanced 3 axis coordinate & free style indent pattern configurator, + CHD, SHD, NHD and edge detection, (supports manual & digital micrometer stages only)	UN-TESTPAT02	* IMP-PACK 2,3,4
			KiC crack detection under load. Palmqvist & Median / Radial fracture toughness	UN-CRKPAP	* IMP-PACK 2,3,4
			Drawing and measuring (distance & angles) application	UN-DRMEAS	* IMP-PACK 2,3,4
			Automatic edge detection	UN-EDGEDTC	* IMP-PACK 2,3,4

		User level management	UN-LEVMAN	* IMP-PACK 2,3,4
		CHD, SHD, NHD configurator & graphic interface for analogue and digital micro meter stage only (not including full pattern editor)	UN-MCHD	* IMP-PACK 2,3,4
		Q-DAS Certified connectivity protocol	UN-QDAS	* IMP-PACK 2,3,4
		Advanced 3-axis communication protocol for robotic systems	UN-REMC	-
		ISO bullets casings pattern configurator and reporting system	UN-SHELLCONF	-
		Artificial Intelligence Deep Learning Brinell module	UN-AIDLBO1	-
	Connectivity Plus	Bluetooth connectivity	UN-BTADAPT	* IMP-PACK 2,3,4
		Wireless system Keyboard & wireless mouse	UN-SKBSET	* IMP-PACK 2,3,4
		Utility software; Import test results in MS applications like Excel	UN-SW/905	* IMP-PACK 2,3,4
Machine stands	(A)	Cabinet test table with drawer for hardness testers 71x75x80cm	UN-STAND/960	
	(B)	Cabinet test table with drawer for hardness testers 150x75x80cm	UN-STAND/965	
		Seaworthy packing box for 950/960	PACK/100	
		Seaworthy packing box for 965	PACK/200	
Vibration isolation stage		Passive vibration isolation stage, broad spectrum	UN-AVS-150	
Printer		Laser Printer	UN-PRINT	
Machine cover		Machine cover 350x550x770mm	UN-COVER1	
ISO 17025 UKAS		UKAS EN ISO 17025 Direct/Indirect calibration report	CCERTFEE/UKAS	
ISO 17025 UKAS ISO / ASTM Calibration		BRINELL direct and indirect calibration & certification, traceable, in compliance with ISO & ASTM, NADCAP. Flat fee for selected common scales, per scale.	CCERTUKAS/1B	
ISO 17025 UKAS ISO / ASTM Calibration		VICKERS direct and indirect calibration & certification, traceable, in compliance with ISO & ASTM, NADCAP. Flat fee for selected common scales, per scale.	CCERTUKAS//1V	
ISO 17025 UKAS ISO / ASTM Calibration		KNOOP direct and indirect calibration & certification, traceable, in compliance with ISO & ASTM, NADCAP. Flat fee for selected common scales, per scale.	CCERTUKAS/1K	

* Available in combination with mentioned IMP-PACK.

SOFTWARE PACKS

GUI: Full tester & configuration control, 3 simultaneous conversions to other hardness scales, limit settings, color indication for measuring results, results list with highlighted in and out of limit values, graphics engine to display turret positions and indenter positions, test force progress bar.	STANDARD	
Full tester configuration & control system, automatic brightness & contrast setting, automatic measurement of Vickers, Knoop and Brinell indents, manual CHD, SHD, NHD testing procedure, Kic measurement, set up and storing of test programs, set up and storing of tester configuration, limits (go/no go), diagrams, advanced report generator with editor. NO INSTALLATION, NO ADDITIONAL PC REQUIRED!	400G2/IMP-PACK2	
Full tester configuration & control system, automatic brightness & contrast setting, automatic measurement of Vickers, Knoop and Brinell indents, manual CHD, SHD, NHD testing procedure, Kic measurement, set up and storing of test programs, set up and storing of tester configuration, limits (go/no go), diagrams, advanced report generator with editor. NO INSTALLATION, NO ADDITIONAL PC REQUIRED!	400G2/IMP-PACK3	
Full tester configuration & control system, automatic brightness & contrast setting, automatic measurement of Vickers, Knoop and Brinell indents, manual CHD, SHD, NHD testing procedure, Kic measurement, set up and storing of test programs, set up and storing of tester configuration, limits (go/no go), diagrams, advanced report generator with editor. NO INSTALLATION, NO ADDITIONAL PC REQUIRED!	400G2/IMP-PACK4	

ACCESSORIES

EYE PIECES



OBJECTIVES



INDENTERS

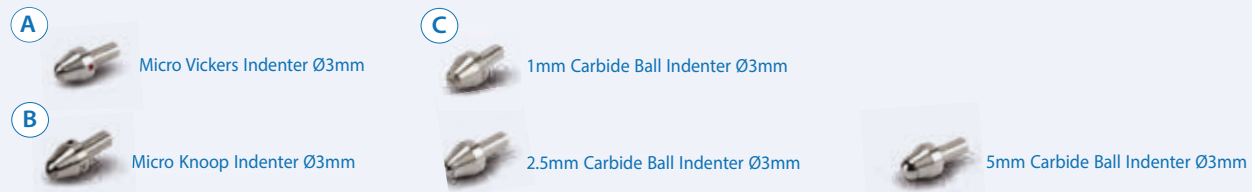

STAGES



ANVILS



FIXTURES AND VICES



SAMPLE HOLDERS



MACHINE STANDS



VIBRATION ISOLATION STAGE



SPECIFICATIONS

HARDNESS SCALES

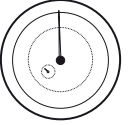
	VICKERS ISO 6507 ASTM E384, E92 JIS B 7725	HV0.001 HV0.010 HV0.015 HV0.020 HV0.025 HV0.050 HV0.1 HV0.2 HV0.3 HV0.5 HV1 HV2 HV2.5 HV3 HV4 HV5 HV10 HV20 HV25 HV30 HV40 HV50 HV60
	KNOOP ISO 4545 ASTM E92 JIS Z 2251	HK0.001 HK0.002 HK0.003 HK0.005 HK0.006 HK0.007 HK0.008 HK0.009 HK0.010 HK0.015 HK0.020 HK0.025 HK0.1 HK0.2 HK0.3 HK0.5 HK1 HK2 HK2.5 HK3 HK4 HK5
	BRINELL ISO 6506, ASTM E10 JIS Z 2243	HBW1/1 HBW1/1.25 HBW1/2.5 HBW1/5 HBW1/10 HBW1/30 HBW2.5/6.25 HBW2.5/7.8125 HBW2.5/15.625 HBW2.5/31.25 HBW2.5/62.5 HBW5/25 HBW 5/62.5
	CONVERSIONS	Conversion to other hardness scales according to ASTM E140, ISO 18265, GB/T 1172

TEST FORCE

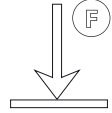
	Force application	Multi-load cell, closed loop, force feedback system
	Test forces	1gf – 62.5kgf
	Force range	FALCON 400G2 1gf – 62.5kgf
	Test force tolerance	< 0.5% for all test forces
	Dwell time settings	Default 10 seconds, user defined.

TURRET

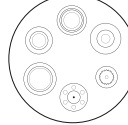
	Motorized turret	Ultra-fast, 6 position turret, 2 indenter positions, 4 objective positions
	Objectives	Long working distance 5x, 10x, 20x, 50x, 100x
	Indenters	Certified indenters (ISO/ASTM) available at choice
	Eyepiece	Analogue eyepiece with 15x magnification Electronic digital eyepiece with 15x magnification
	Camera	11 Mpx

SYSTEM

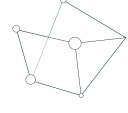
	Electronic system	High performance embedded electronics system running I-TOUCH™ firmware
	Screen(s)	6.5" display, 27" LCD screen (IMP-PACK)
	Display resolution	0.1 HV, HK, 0.5 HB
	Statistics	Total test, max, min, average, range, standard deviation, All in real time after each test
	Hardness conversion	Rockwell, Rockwell Superficial, Vickers, Brinell, Knoop, Leeb & Tensile
	Software	I-TOUCH™ firmware, workflow system & tester control IMPRESSIONS™ V4, workflow system & tester control (IMP-PACK)
	Data output	USB
	Connectivity	USB-2
	Printer	A4, A3 full color laser printer (optional)

GENERAL

	Machine dimension	528mm x 384mm x 695mm
	Workpiece accommodation	145mm (H) x 170mm (D)
	Machine weight	75 kg
	Power supply	100VAC to 240VAC, 50/60Hz, single phase
	Operating temperature	10°C to 35°C
	Noise	< 70 db(A)
	Power consumption	75W
	Humidity	10% to 90%, non-condensing

TECHNICAL DRAWINGS

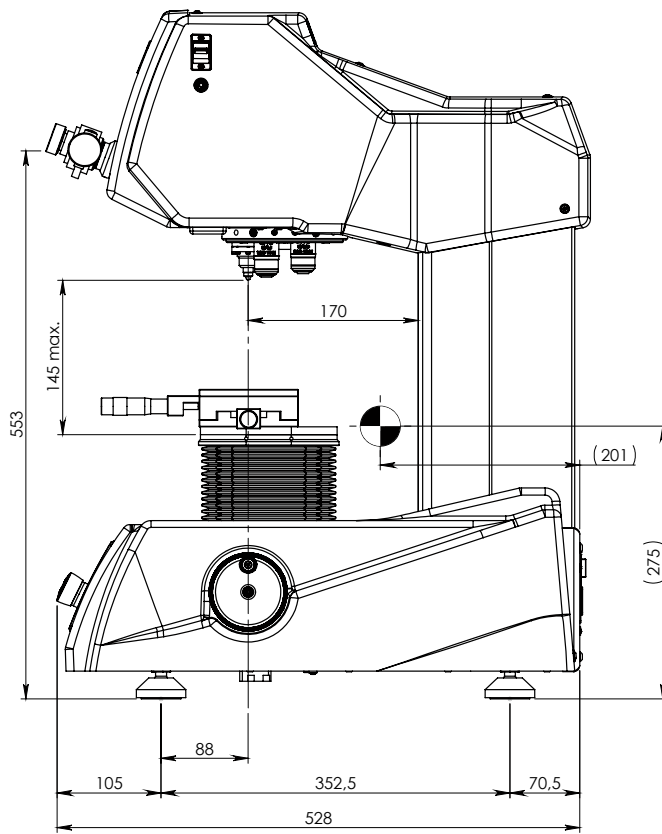

All dimensions in these drawings are in mm, approximate. Working heights and or workpiece accommodation varies depending on the stages and stage accessories used.

Please contact our sales department for more details.

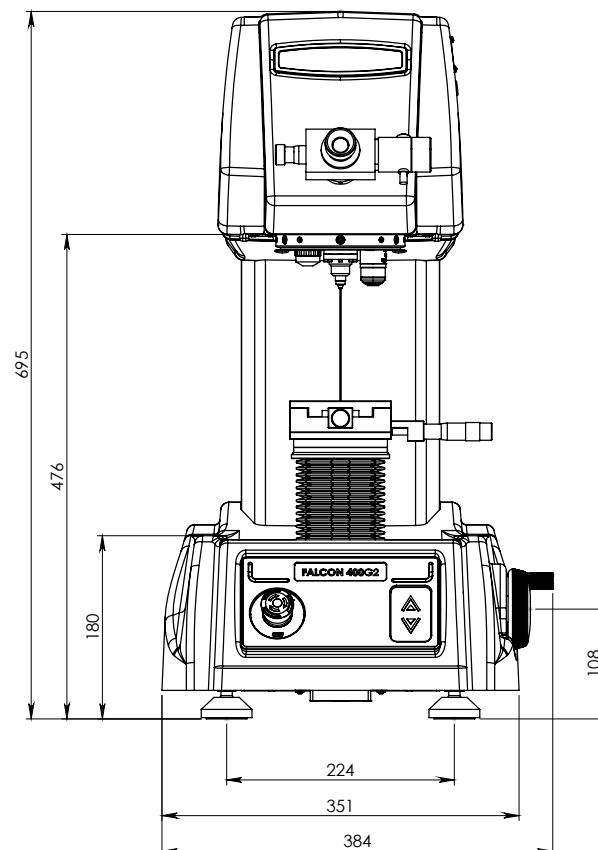

OTHER MODELS IN THE FALCON RANGE



FALCON 450G2

Load Cell, closed loop
Macro/Micro Vickers, Knoop & Brinell Hardness tester.
With Z-axis handwheel

See brochure B22F450G2/XX



FALCON 500G2

Multi Load Cell, closed loop
Fully automatic, free to
configure Micro/Macro Vickers,
Knoop & Brinell Hardness
testers. With ball screw
motorized Z-axis

See brochure B22F500G2/XX



FALCON 600G2

Multi Load Cell, closed loop
Fully automatic, free to
configure Micro/Macro Vickers,
Knoop & Brinell Hardness
testers. With ball screw
motorized Z-axis

See brochure B22F600G2/XX



FALCON 5000G2

Multi Load Cell, closed loop
Fully automatic, 8 position
turret, laser positioning.
Micro/Macro Vickers, Knoop
& Brinell Hardness testers.
Descending test head,
fixed work piece position

See brochure B22F5000G2/XX

Changes in products and/or product specifications can emerge due to new technologies and continuous development.

We reserve the right to change or modify specifications of the products without prior notice. We recommend you to contact our sales office for up-to-date information.

Brochure B22F400G2/02/EN

EUROPE

INNOVATEST Deutschland GmbH.
Sales & Service
Phone: +49 245 670 59 500
info@innovatest-deutschland.com
www.innovatest-deutschland.com

INNOVATEST France SARL
Sales & Service
Phone: +33 1 848 88038
commercial@innovatest-france.com
www.innovatest-france.com

INNOVATEST UK Ltd.
Sales & Service
Phone: +44 (0) 121 824 4775
info@innovatest-uk.com
www.innovatest-uk.com

INNOVATEST Polska sp. z o.o
Sales & Service
Phone: +48 697 099 826
info@innovatest-polska.pl
www.innovatest-poland.com

MIDDLE EAST

INNOVATEST Middle East LLC
Sales & Service
Phone: +971 56 372 6114
info@innovatest-mideast.com
www.innovatest-mideast.com

NORTH-AMERICA

INNOVATEST USA Inc.
Sales & Service
Phone: +1 267 317 4300
info@innovatest-usa.com
www.innovatest-usa.com

ASIA

INNOVATEST Shanghai Co., Ltd.
Sales & Service
Phone: +86 21 60906200
Fax: +86 21 60912595
info@innovatest-shanghai.com
www.innovatest-shanghai.com

INNOVATEST Japan Co., Ltd.
Sales & Service
Phone: +81 3 3527 3092
Fax: +81 3 3527 3093
info@innovatest-japan.com
www.innovatest-japan.com

INNOVATEST South East Asia
Sales & Service
Phone: +65 6451 1123
Fax: +65 6452 1011
info@innovatest-singapore.com
www.innovatest-singapore.com

Distributor :

CORPORATE HEAD OFFICE

INNOVATEST Europe BV
Manufacturing, Distribution & Service
Borgharenweg 140
6222 AA MAASTRICHT
The Netherlands

Phone: +31 43 3520060
Fax: +31 43 3631168
info@innovatest-europe.com
www.innovatest-europe.com